

INSTALLATION MANUAL

MONTERINGSANVISNING
MONTERINGSANVISNING
MONTERINGSVEJLEDNING
ASENNUSOHJE

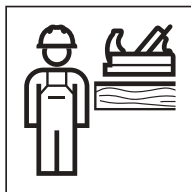

970.698.00.0(00)

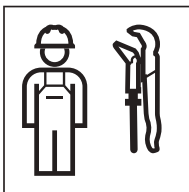

1

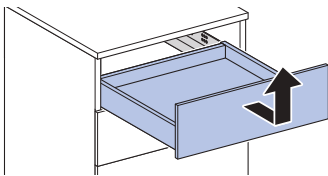
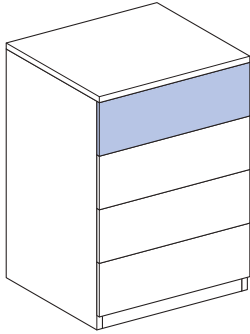

2

1

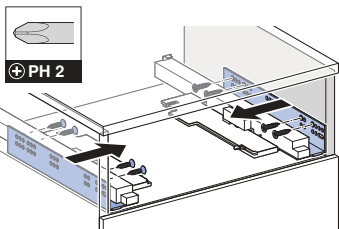

2

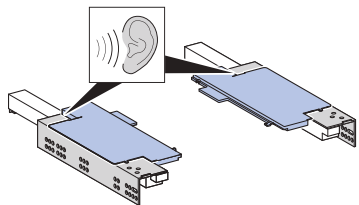
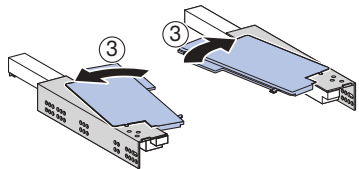
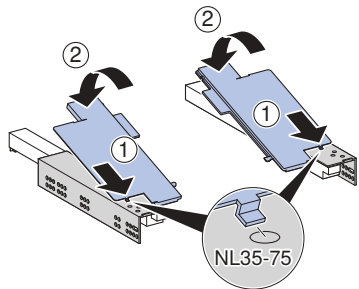
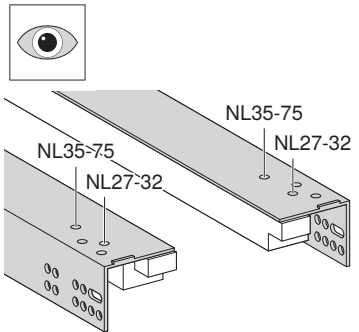

3

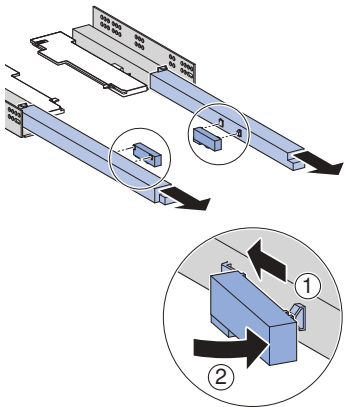

4

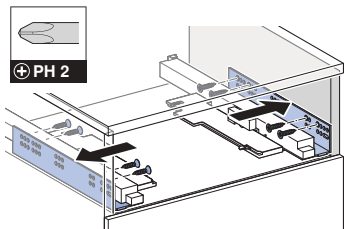

5

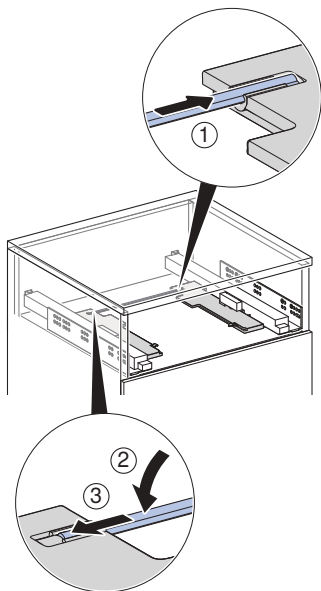

3

1

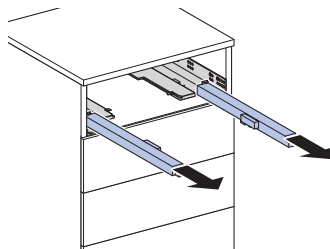

2

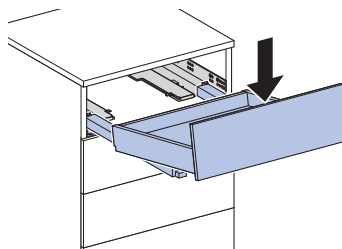

3

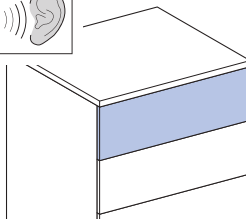
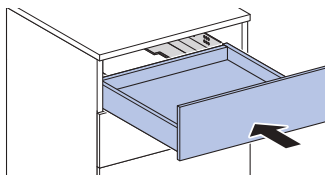

4

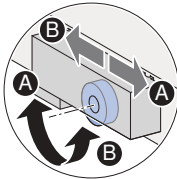
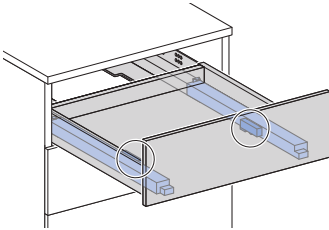
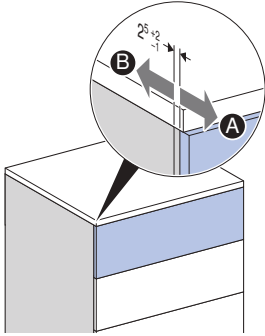

5

1

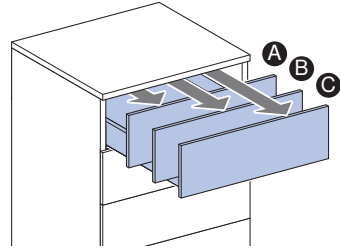
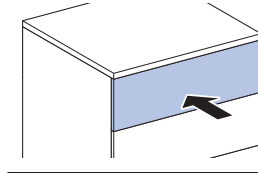

2

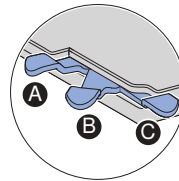
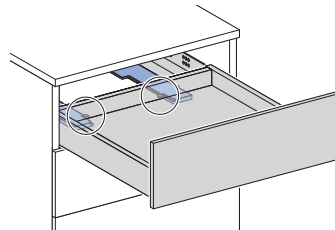

Geberit International AG
Schachenstrasse 77, CH-8645 Jona
documentation@geberit.com
www.geberit.com

